



Component Specification

C00539

**Datamate
M80 & M83 Series Rectangular Connectors
November 2021**

SECTION	TITLE	PAGE
1	Description of Connectors and Intended Applications	2
2	Ratings	2
Appendix 1	Contact Orientations	6
Appendix 2	Coax Contact Details (Datamate Mix-Tek)	9
Appendix 3	Gauges (Low Frequency Contacts)	12
Appendix 4	Test for Latch Integrity (Datamate L-Tek)	13
Appendix 5	Instructions for the use of Connectors fitted with Jackscrews	14
Appendix 6	Instructions for the use of 101Lok Fixings	15

1. DESCRIPTION OF CONNECTOR AND INTENDED APPLICATION

A range of 2mm pitch male and female rectangular, fully shrouded unsealed connectors with replaceable contacts for interconnecting board to board, cable to board and cable to cable. The range covers 2 to 96 ways, in various application methods. Female connectors are available for crimp, vertical throughboard and surface mount termination. Male connectors are available for crimp, vertical or horizontal (90°) throughboard and surface-mount termination. Pre-cabled contacts and cable assemblies are also available in various options.

The connectors are provided with a range of contact terminations (as shown in Appendix 1) that are gold or tin plated. The contact zone of a gold plated contact is hard acid gold of 98% purity.

The connector is intended for use as a low voltage connector in high packing density electronic equipment. The connector is polarised to prevent mis-matching and can be produced with a latching feature (L-Tek) or in a jackscrew (J-Tek) format, with or without board mounting.

L-Tek and J-Tek connectors are available with low-frequency (LF) contacts, while mixed technology (Mix-Tek) connectors are also available with jackscrews, with a choice of power or coax contacts.

NOTE: Some connector styles are available manufactured and tested to BS9525 F0033. All other connectors in the range are designed to the same specification. For cable assembly specifications see Component Specification C049XX (where XX is latest issue).

2. RATINGS

2.1. Low-Frequency Signal Contacts

2.1.1. Current Rating

Standard Signal Contact:

One contact per connector is electrically loaded, 25°C ambient	3.3A max
One contact per connector is electrically loaded, 85°C ambient	2.6A max
Current per contact through all contacts, 25°C ambient.....	3.0A max
Current per contact through all contacts, 85°C ambient	2.2A max

T-Contact:

One contact per connector is electrically loaded, 25°C ambient	8.5A max
One contact per connector is electrically loaded, 85°C ambient	6.5A max
Current per contact through all contacts, 25°C ambient.....	3.5A max
Current per contact through all contacts, 85°C ambient	2.6A max

Flex Circuit Assembly:

Current per individual track, 25°C ambient	1.0A max
--	----------

2.1.2. Other Electrical Characteristics

Working Voltage (at 1,013mbar, sea level):

Pre-Cabled Contacts & Cable Assemblies	300V DC or AC peak
Others.....	800V DC or AC peak

Voltage Proof (at 1,013mbar, sea level) 1,200V DC or AC peak

Contact Resistance:

Initial	20mΩ max
After Conditioning	25mΩ max

Insulation resistance:

Initial	1,000MΩ min
Hot After Conditioning	100MΩ min

Creepage Path contact-to-contact 0.35mm min

Air Gap contact-to-contact..... 0.35mm min

2.1.3. Environmental Characteristics

Environmental Classification.....	55/125/56 Days at 95% RH
Operating Temperature Range.....	-55°C to +125°C
Low Air Pressure Severity (only one contact is electrically loaded).....	300 mbar (9,144m/30,000ft)
<i>The connector will function correctly using a simultaneous combination of high temperature and low air pressure down to 300mbar (altitude of 9,144m/30,000ft) up to 360V DC.</i>	
Salt Spray:	
L-Tek.....	BS2011 Part 2.1Kb Severity 2 (5% Solution, 6.5/7.2pH @ 40°C, 93% Humidity for 66 hours)
J-Tek & Mix-Tek	EIA364 Test Procedure 26 condition A (5% Solution, 6.5/7.2pH @ 35°C, 95% Humidity for 96 hours)

2.1.4. Vibration, Shock, Bump

In all cases, mating jackscrews or latches are fully utilized.

Standard Signal Contact:	
Vibration Severity (10G test)	10Hz to 2,000Hz, 0.75mm, 98m/s ² (10G), duration 6 hours
Vibration Severity (20G test)	10Hz to 81.73Hz, 1.5mm peak-to-peak; 57.55Hz to 2,000Hz, 196.2m/s ² (20G), duration 2 hours
Shock Severity	981m/s ² (100G), 18 shocks total
Bump Severity	390m/s ² (40G), 4,000±10 bumps
T-Contact:	
Vibration Severity	10Hz to 13.6Hz, 35mm peak-to-peak, 13.6Hz to 41.6Hz, 1.5mm peak-to-peak, 41.6Hz to 2,000Hz, 392.4m/s ² (40G), duration 6 hours
Shock Severity	981m/s ² (100G)

2.1.5. Mechanical Characteristics

Clip Retention in Body	18N min
<i>Minimum retention force may be 10N from a sample of 10 sockets, providing the average of the samples is 22N.</i>	
High Temperature, Long Term (current as in 2.1.1.)	1,000 hours at 85°C
High Temperature, Short Term (no electrical load)	250 hours at 125°C
Contact Retention in Housing	10N min
Contact Replacement in Housing (Male Crimp Jackscrew)	2 operations at 10N
Durability:	
Standard Signal Contact	500 operations
T-Contact	1,000 operations
Contact holding force (Standard Signal Contact)	0.2N min
Insertion Force (per contact, when mated to standard mating pin, no fixings):	
M80 Standard Signal Contact	2.0N max
M83 Signal Contact	1.0N max
T-Contact	4.0N max
Withdrawal Force (per contact, when mated to standard mating pin, no fixings):	
M80 Standard Signal Contact	0.2N min
M83 Signal Contact	0.2N min
T-Contact	0.5N min
Cable Contact Replacement in Housing	up to 2 times max
Contact Wipe (T-Contact)	2.00mm min

2.1.6. Wire Termination Range

Recommended Wire Type See Component Specification C049XX (latest issue)

Crimp Type	AWG Wire Size	Qty & Nominal diameter (mm) of strands	Minimum pull-off force	M22520/2-01 Crimp tool setting	Max. insulation diameter
Extra Small Bore	32	7/0.08	4.0N	4	Ø0.75mm
	30	1/0.25	7.0N	4	
	28	7/0.12	12.5N	5	
Small Bore	28	7/0.12	12.5N	6	Ø1.10mm
	26	7/0.15	25.0N	6	
	24	7/0.2	44.0N	6	
Large Bore	22	19/0.15	50.0N	6	
T-Contact	22	19/0.15	50.0N	6	

2.2. Coax Contacts

2.2.1. Electrical Characteristics

Impedance 50Ω
 Frequency Range 6GHz (Also dependent on cable type or board layout)
 VSWR (Voltage Standing Wave Ratio):
 M80-310 1.19 + (0.04 x Frequency) GHz max
 Others 1.05 + (0.04 x Frequency) GHz max
 Voltage Rating (at 1,013mbar, sea level) 180V AC at 500mA
 Voltage Proof (at 1,013mbar, sea level) 1,000V AC_{rms}
 Contact Resistance 6mΩ max
 Insulation Resistance (at 250V rms) 10⁶ MΩ

2.2.2. Wire Termination Range

Cable Type	Max. Insulation Diameter	Compatible contacts
RG 178	Ø2.0mm	M80-305, M80-308, M80-315, M80-318
RG 174	Ø2.7mm	M80-307, M80-309, M80-317, M80-319
RG 179		
RG 316		
UT 047	Ø1.2mm (outer conductor)	M80-310

2.2.3. Mechanical Characteristics

Durability 500 operations
 Insertion Force (per contact, using mating contact, no fixings) 20.0N max
 Withdrawal Force (per contact, using mating pin, no fixings) 0.5N min
 Contact Wipe 1.30mm min
 Contact Replacement in Housing 5 times max

2.3. Power Contacts

2.3.1. Electrical Characteristics

Current Rating:	
M80-3XX contact	20A max
M80-PXX contact	40A max
Working Voltage (at 1,013mbar, sea level)	800V DC or AC peak
Voltage Proof (at 1,013mbar, sea level)	1,200V DC or AC peak
Contact Resistance	6mΩ max

2.3.2. Wire Termination Range

Recommended Wire Type See Component Specification C049XX (latest issue)

AWG	Current Rating of cable	Compatible contacts
10	40A max	M80-PF5, M80-PM5
12	20A max	M80-325, M80-335, M80-32A
14	15A max	M80-326, M80-336, M80-32B
16	10A max	M80-327, M80-337, M80-32C
18	8A max	M80-328, M80-338
20	5A max	M80-329, M80-339

2.3.3. Mechanical Characteristics

Durability.....	500 operations
High Temperature, Long Term (no electrical load).....	1,000 hours at 150°C
Insertion Force:	
M80-3XX contact	8.0N max
M80-PXX contact	15.0N max
Withdrawal force.....	0.5N min
Contact wipe.....	1.30mm min
Contact Replacement in Housing	5 times max

APPENDIX 1 – CONTACT ORIENTATIONS

These diagrams show pin numbers with reference to the polarisation feature. They represent male connectors, shown looking onto the contact face. For female connectors looking on the mating face, the numbering will be mirrored.

A1.1. Datamate L-Tek – Single Row

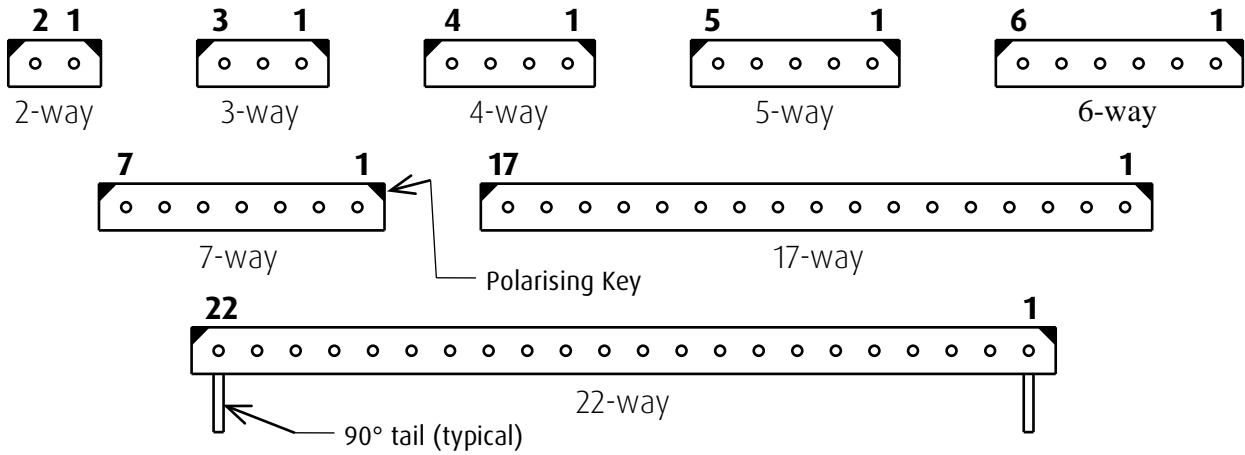

A1.2. Datamate L-Tek – Double Row

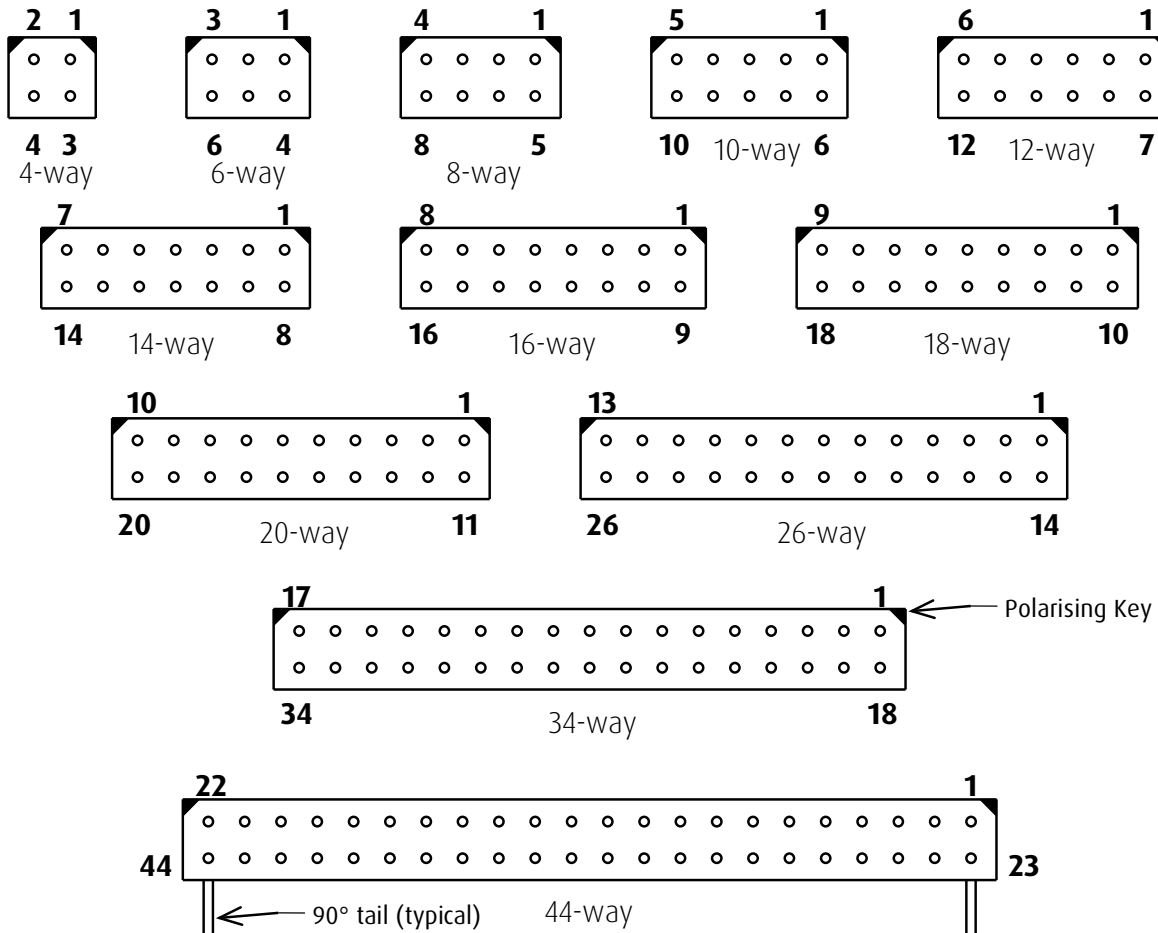

APPENDIX 1 – CONTACT ORIENTATIONS (continued)

These diagrams show pin numbers with reference to the polarisation feature. They represent male connectors, shown looking onto the contact face. For female connectors looking on the mating face, the numbering will be mirrored.

A1.3. Datamate J-Tek – Double Row

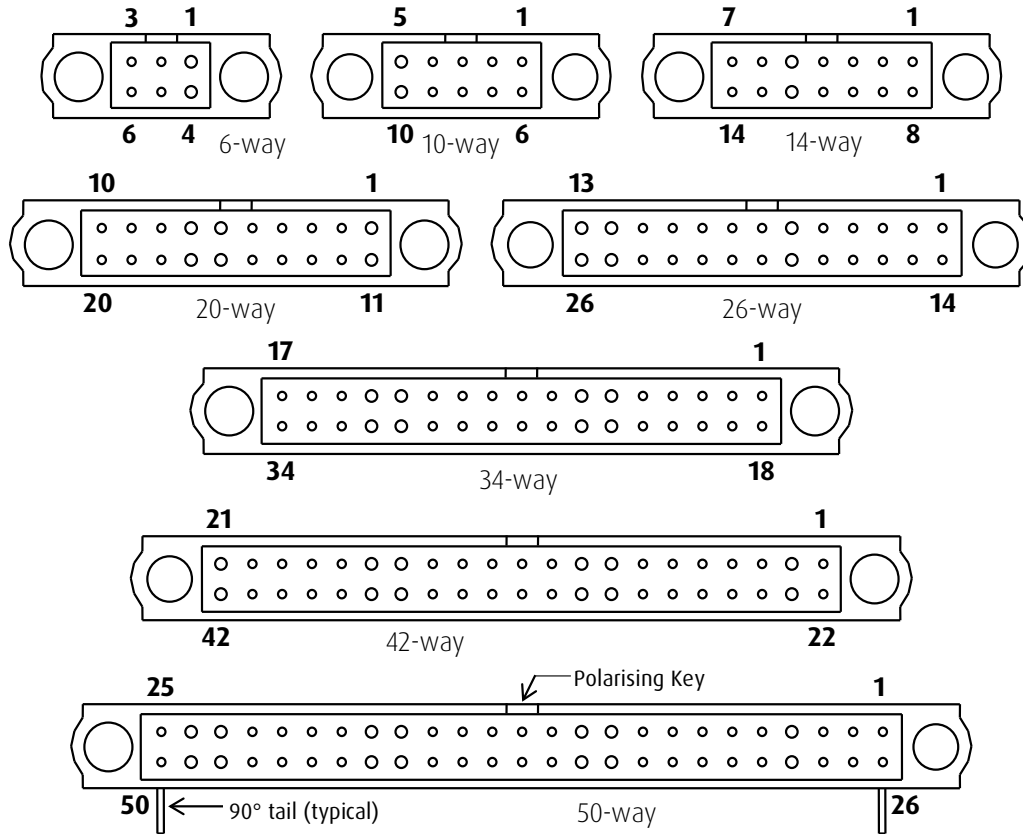

A1.4. Datamate J-Tek 3-Row (M83 series)

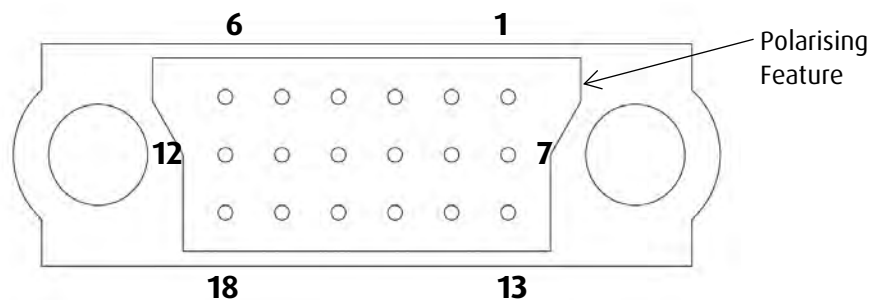

Only signal contacts (18-contact version shown, others follow the same pattern)

APPENDIX 1 – CONTACT ORIENTATIONS (continued)

These diagrams show pin numbers with reference to the polarisation feature. They represent male connectors, shown looking onto the contact face. For female connectors looking on the mating face, the numbering will be mirrored.

A1.5. Datamate Mix-Tek

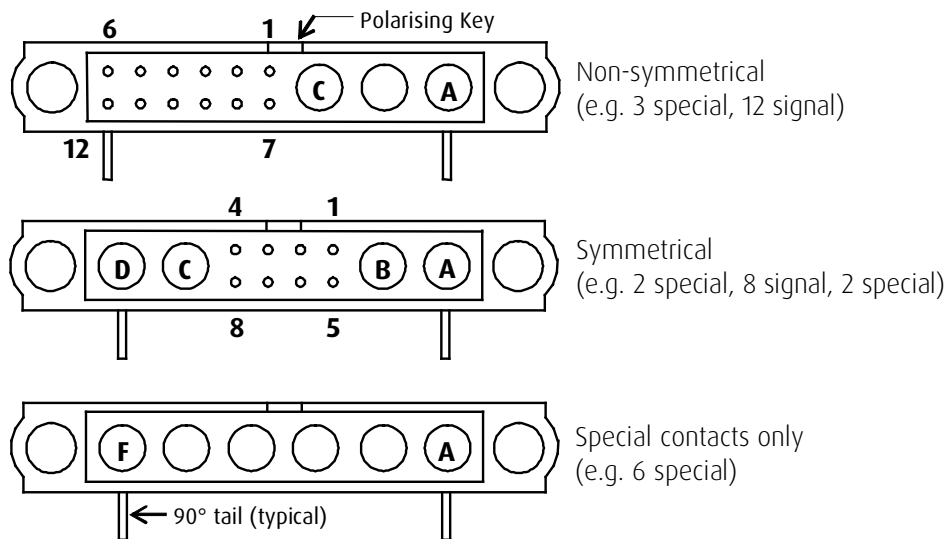

A1.6. Damatate Mix-Tek 3-Row (M83 Series)

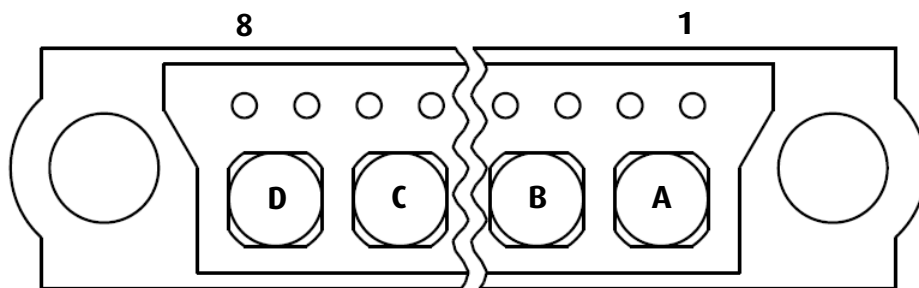

Signal and special contacts

APPENDIX 2 – COAX CONTACT DETAILS

A2.1. Coax Contact Interface Dimensions

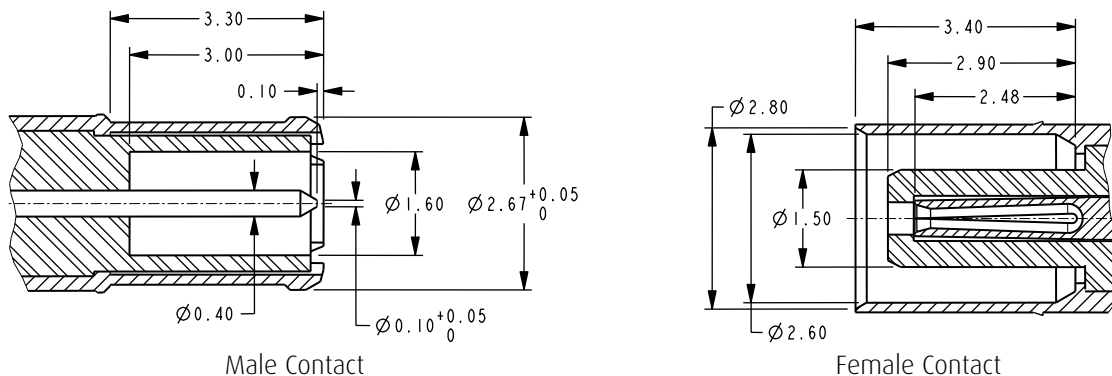

A2.2. Coax Contact Assembly Instructions – M80-305/307, M80-315/317

- 1) Strip cable to dimensions shown against relevant part (see appropriate technical drawing).

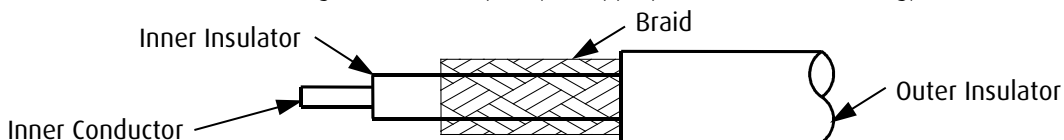

- 2) Identify pieces of coax connector to be assembled.

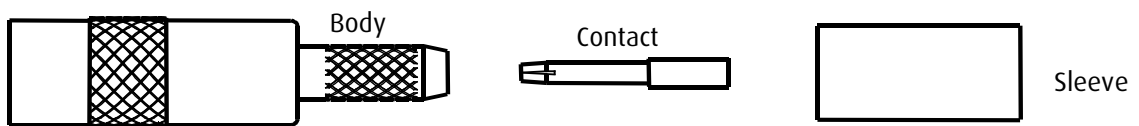

- 3) Slide sleeve onto cable past stripped area.

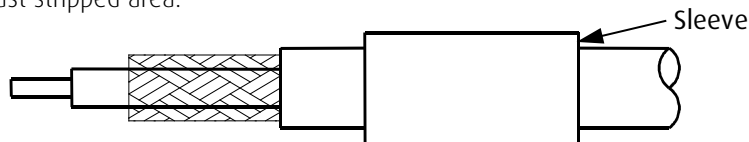

- 4) Crimp contact to end of cable inner conductor.

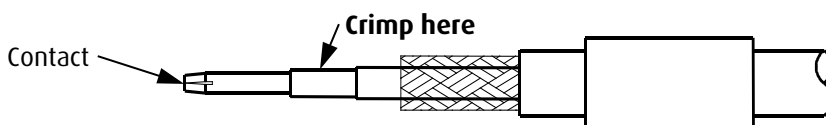

- 5) Insert cable and contact into coax body from back end – make sure that the braid goes outside and over the end section.

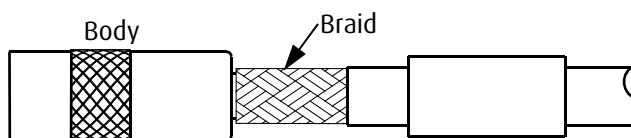

- 6) Slide sleeve back over the end of the coax body and the braid. Crimp into place on the cable insulation, using a hexagonal crimping tool.

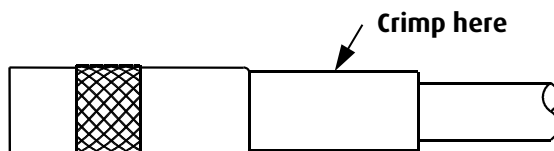

APPENDIX 2 – COAX CONTACT DETAILS (continued)

A2.3. Coax Contact Assembly Instructions – M80-308/309, M80-318/319.

- 1) Strip cable to dimensions shown against relevant part (see appropriate engineering drawings).

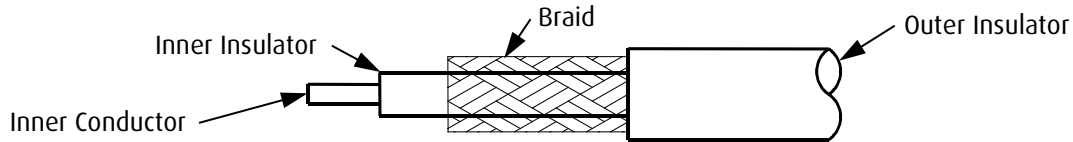

- 2) Identify pieces of coax connector to be assembled.

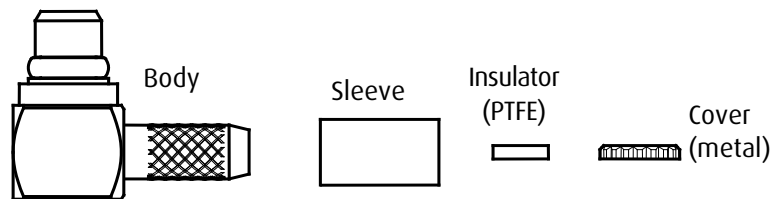

- 3) Slide sleeve onto cable past stripped area.

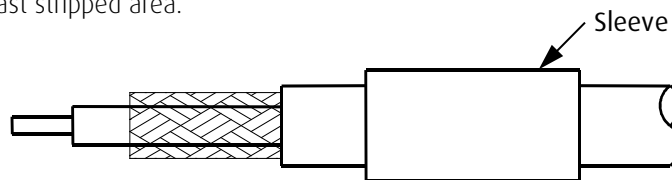

- 4) Push the cable and sleeve into the body, as far as it will go. The cable inner conductor will be visible through the hole in the back of the coax body, and should go into the slot in the inner contact. Make sure that the braid goes outside and over the end section.

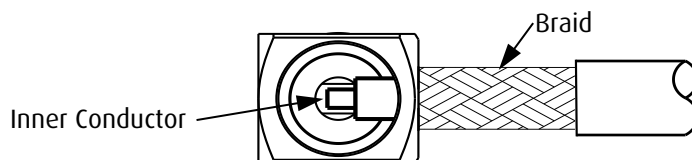

- 5) Solder the cable inner conductor to the body inner contact. When cool, place the insulator inside the top, and press the cover into place. Slide the sleeve up to meet the coax body, and hexagonal crimp in place.

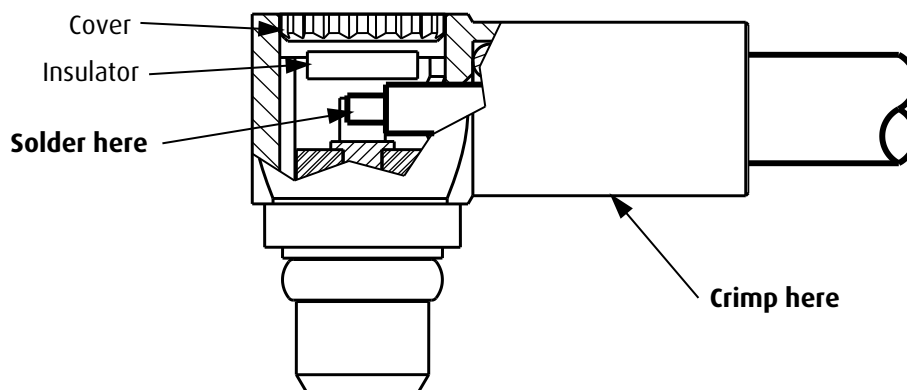

APPENDIX 2 – COAX CONTACT DETAILS (continued)

A2.4. Coax Contact Assembly Instructions – M80-310.

- 1) Strip cable to dimensions shown against relevant part (see appropriate engineering drawings).

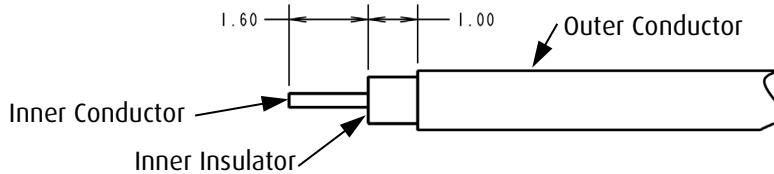

- 2) Identify pieces of coax connector to be assembled.

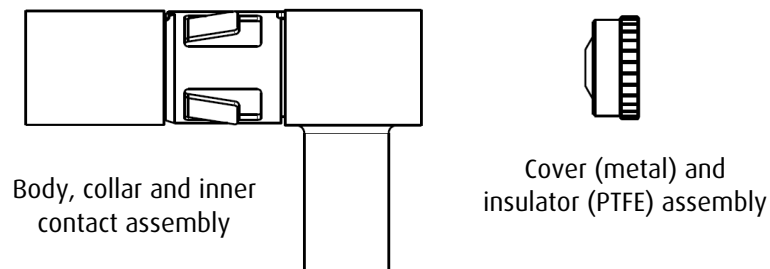

- 3) Push the cable into the body, as far as it will go. The cable inner conductor will be visible through the hole in the back of the coax body, and should go into the slot in the inner contact.

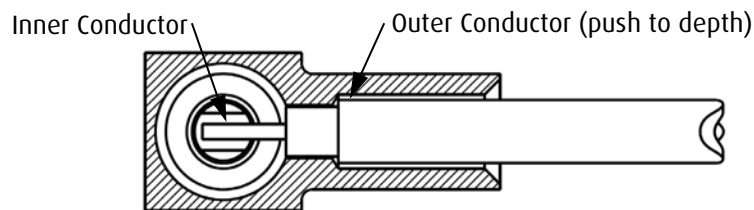

- 4) Solder the cable inner conductor to the body inner contact. When cool, press the cover into place (with the insulator on the inside of the contact). Solder the cable outer conductor to the contact body.

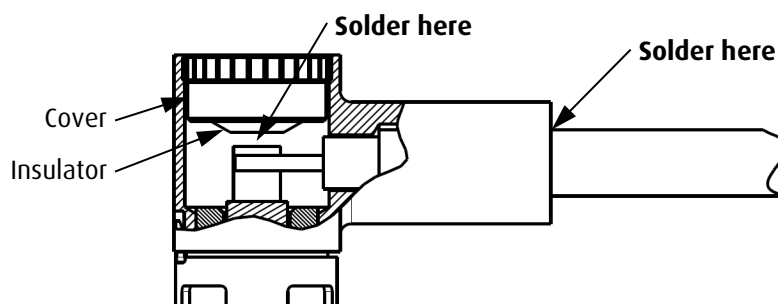

APPENDIX 3 – GAUGES (LOW FREQUENCY)

NOTES:

1. Material = Steel to BS1407 or equivalent.
2. Gauging surfaces to be hardened/ground to 650 H.V. minimum.
3. These gauges to be used for testing fully assembled components only.
4. Ultimate wear limit of 0.005mm is allowable on gauging diameters.
5. Loading force (Bending moment) to give 0.002Nm (Test prod only).
6. All dimensions are in millimetres.
7. For explanation of dimensions, etc. see BS8888.
8. Unless otherwise stated, all dimensions are maxima.

A3.1. Test Prod

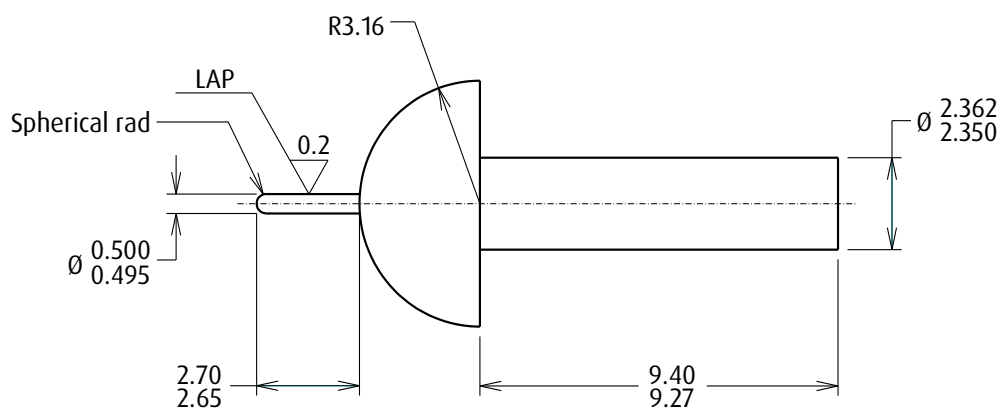

A3.2. Sizing Gauge

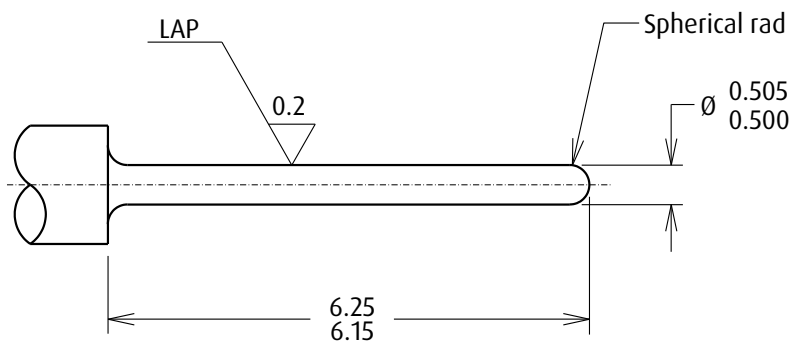

A3.3. Holding Gauge

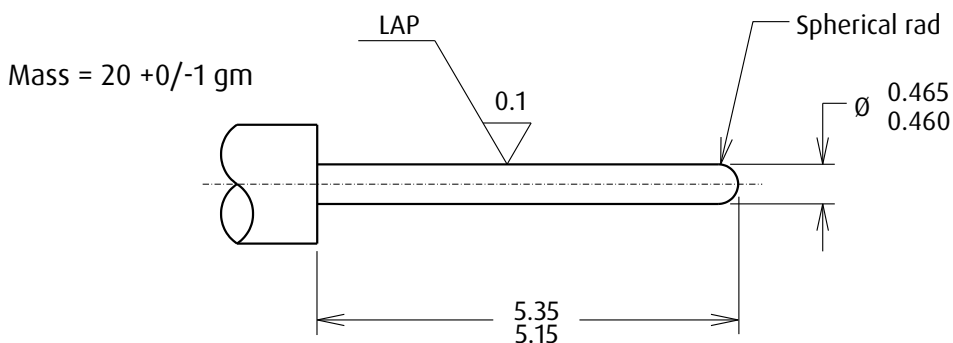

APPENDIX 4 – TEST FOR LATCH INTEGRITY ON L-TEK

When an unloaded female connector moulding is mated with a latched male connector, and a force of 20N is applied for 10 seconds in the directions shown in Figure 1, there shall be no failure of any part of the latch mechanism.

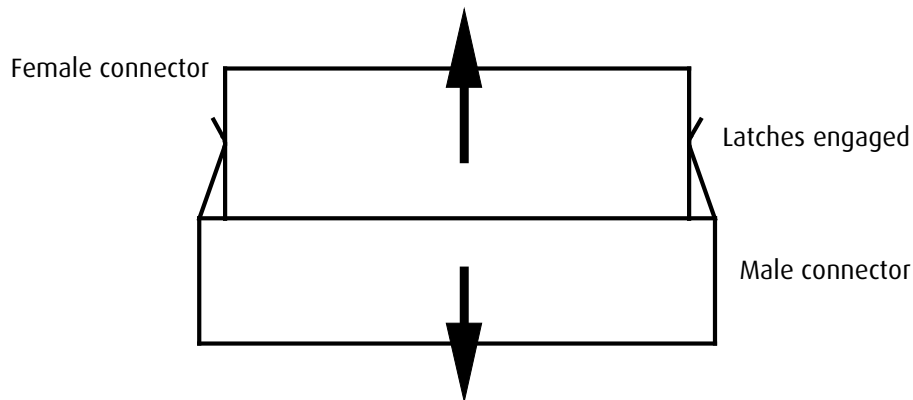

Figure 1

APPENDIX 5 – INSTRUCTIONS FOR THE USE OF CONNECTORS FITTED WITH JACKSCREWS

Connectors are fitted with jackscrews where it is considered necessary to provide mechanical assistance in ensuring a satisfactory engagement and separation of the connector. This may apply in cases where engagement and separation forces are so high as to prevent satisfactory hand engagement, or where access to connector is restricted. Jackscrews also provide a locking feature, preventing the connector from disengaging under adverse conditions.

To obtain maximum effectiveness from the jackscrew system, the following rules for their use should be observed.

- 1) The connector with board mount jackscrews should be fixed to the PCB with fixings and tightened to a torque of **21±2cmN**.

Board mount fixings must be fitted before Wave soldering.

Board mount fixings can be fitted before or after reflow soldering, as preferred by customer. If fitted before soldering, check that the fixings remain tight after soldering.

NOTE: Care must be taken when aligning male and female threads, to avoid cross-threading and possible failure of parts.

- 2) On engaging the two halves of the connector after ensuring correct polarity, lightly push home the floating half until the jackscrews touch. Then, maintaining the pressure, turn one of the floating jackscrews clockwise, until it engages with the fixed screw. Repeat with the other screw.

Then screw in each jackscrew, ensuring even loading by applying a maximum of one turn to each screw in sequence until the connector is bottomed. This will be evident by a sudden increase in the torque required on the screw. This torque should not exceed **23cmN**.

Finger pressure exerted at the centre of the connectors may be required to achieve full engagement of both halves.

NOTE: Care must be taken when aligning male and female threads to avoid cross-threading and possible failure of parts.

- 3) On disengaging the two halves of the connector turn each of the floating jackscrews anti clockwise. Again, ensure even loading by turning each screw in sequence for a maximum of one turn until the jackscrew disengage. The connector can then be easily pulled apart.



APPENDIX 6 – INSTRUCTIONS FOR THE USE OF 101LOK FIXINGS

- 1) Before engaging, ensure that the slot on the fixing head is at right angles to the length of the connector.
- 2) Push the connectors together. Once the connectors are mated, use a screwdriver to push down onto each 101Lok fixing until the spring is compressed. Turn the fixing 101 degrees, and release. The 101Lok fixing should remain partially compressed.
- 3) To disengage, use a screwdriver to push down on each 101Lok fixing until the spring is compressed. Turn the fixing anti-clockwise 101 degrees, and release. The 101Lok fixing will spring back to its uncompressed position.