

### Data sheet

#### Dimensions

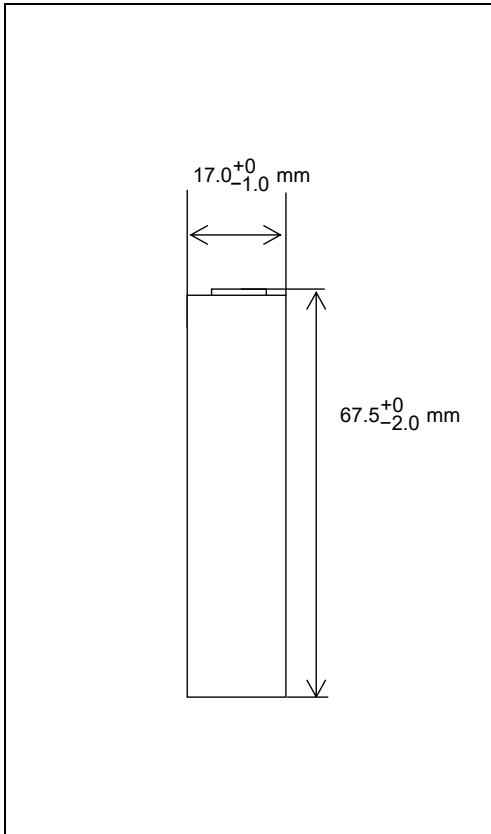

Dimensions (including tube)	Diameter	17.0 +0/ -1.0 mm
	Height	67.5 +0/ -2.0 mm
Approx. Weight (including tube)		53 g
Approx. Internal Impedance at 1kHz 20°C <sub>5)</sub>		20 mΩ

5) After 3 cycles of charge and discharge under the conditions of 1), followed by the measurement 1~4 hours later.

#### Capacity

Nominal <sub>1)</sub>	4000 mAh
Minimum <sub>1)</sub>	3600 mAh

1) Single cell capacity under the following condition.

Charge : 360 mA x 16 hours, Discharge : 720 mA (E.V.=1.00 V) at 20 °C

#### General Specifications

Nominal Voltage		1.2 V
End Voltage		1.00 V
Charging Current x Time		Fast Charge <sub>2)</sub> 3000 mA x about 1.4 hours
Ambient Temp.	Charge Condition <sub>3)</sub>	Fast Charge <sub>2)</sub> 0 °C ~ +40 °C
	Discharge Condition <sub>3)</sub>	Recommended 0 °C ~ +50 °C
Relative Humidity <sub>4)</sub>		45 % ~ 85 %

2) Use recommended charging system.

3) Charge or discharge on outside the recommended temperature range may generate the battery degradation.

4) No water condensation.

#### Storage Conditions

Ambient Temp.	Less than 30 days	-20 °C ~ +50 °C
	Less than 90 days	-20 °C ~ +40 °C
	Less than 1 year	-20 °C ~ +30 °C
Relative Humidity <sub>6)</sub>		45 % ~ 85 %

6) No water condensation.

#### Nominal Charge Characteristics

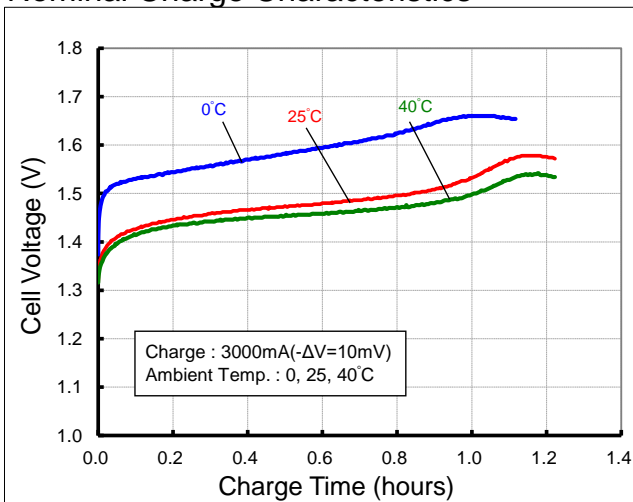

#### Nominal Discharge Characteristics

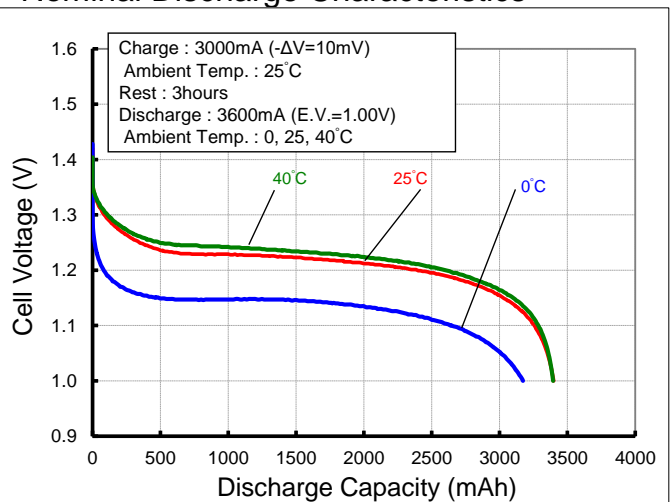

- Single cell performance and lifespan are greatly affected by usage and temperature conditions.
- Test results vary depending on individual cells.
- Each values included in this material are intended to describe performance. They are not guaranteed.